

F90AXP

english

italiano

français

deutsch

español

nederlands



c r a n e s w i t h o u t c o m p r o m i s e

FASSI

CRANES WITHOUT COMPROMISE

F90AXP.21

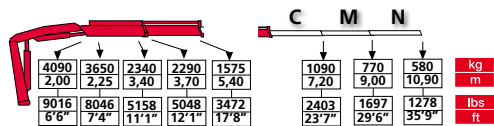

F90AXP.22

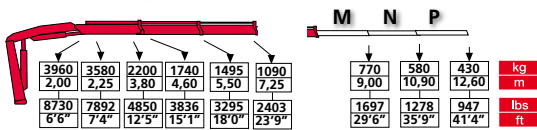

F90ACXP.22

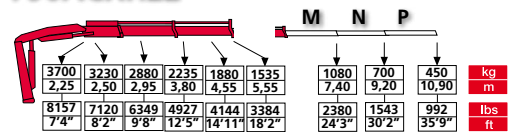

F90AXP.23

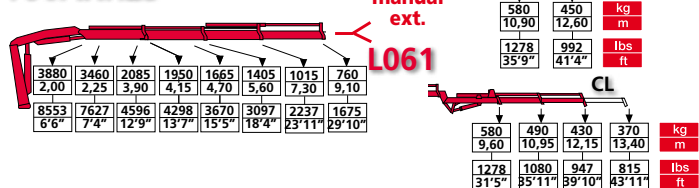

F90ACXP.23

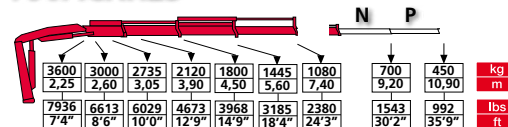

F90AXP.24

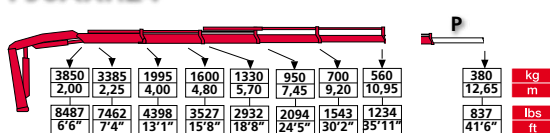

F90ACXP.24

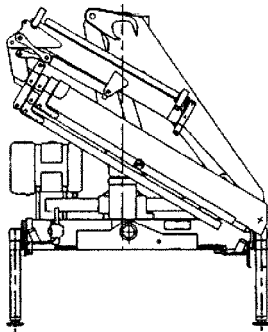
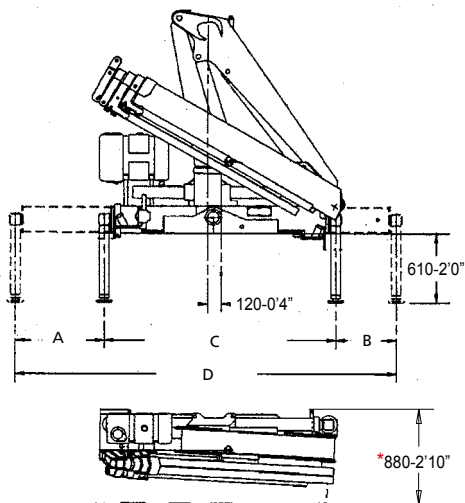
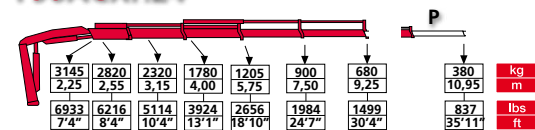

L061 125 Kg 275 lbs
CL 13 Kg 28 lbs

	STD	Extra	Super Extra	Iper Extra	STD	Extra	Super Extra	Iper Extra
A	785	1190	1370	1790	2035	2115	2230	2230
	2'6"	3'10"	4'5"	5'10"	6'8"	6'11"	7'3"	7'3"
B	545	1190	1370	1580	3365	4500	4970	5600
	1'9"	3'10"	4'5"	5'2"	11'0"	14'9"	16'3"	18'4"

* With supplementary hoses
 Con tubazioni supplementari
 Avec tuyauterie supplementaire
 Con tuberias suplementarias
 Mit zusaetzlichen leitungen
 Met extra functies

- GB** 1) FX500 electronic control system
 2) RCH/RCS remote control
 3) MPES system
 4) XP system
- IT** 1) Sistema di controllo elettronico FX500
 2) Radiocomando RCH/RCS
 3) Sistema MPES
 4) Sistema XP
- FR** 1) Système électronique de contrôle FX500
 2) Radiocommande RCH/RCS Evolution
 3) MPES système
 4) XP système
- ES** 1) Sistema electrónico de control FX500
 2) Radiomando RCH/RCS
 3) Sistema MPES
 4) Sistema XP
- DE** 1) FX500-System, die elektronische Lastmomentbegr.
 2) RCH/RCS-Funkfern-steuerung
 3) Multi-Power Ausschubsystem
 4) System XP
- NL** 1) FX500 elektronisch beveiligingssysteem
 2) RCH/RCS Evolutie radiografische afstandsbediening
 3) MPES-systeem
 4) XP-systeem

	tm	lbs.ft	m	ft	m	ft	°	kNm	lbs.ft	Mpa	psi	l/min	gal/min	l	gal	kg	lbs	mm	ft	mm	ft	mm	ft
F90AXP.21	8,5	61480	5,60	18'4"	1,70	5'6"	370	11,7	8632	32,0	4640	20	5	60	16	960	2118	2200	7'3"	700	2'4"	1970	6'6"
F90AXP.22	8,4	60757	7,40	24'4"	3,45	11'3"	370	11,7	8632	32,0	4640	20	5	60	16	1025	2260	2200	7'3"	720	2'4"	1970	6'6"
F90AXP.23	8,1	58587	9,25	30'4"	5,20	17'0"	370	11,7	8632	32,0	4640	20	5	60	16	1110	2447	2200	7'3"	720	2'4"	1970	6'6"
F90AXP.24	8,0	57864	11,10	36'5"	6,95	22'9"	370	11,7	8632	32,0	4640	20	5	60	16	1170	2579	2200	7'3"	720	2'4"	1970	6'6"
F90ACXP.22	8,6	62204	5,70	18'9"	2,60	8'6"	370	11,7	8632	29,0	4210	20	5	60	16	990	2182	2200	7'3"	720	2'4"	1970	6'6"
F90ACXP.23	8,3	60034	7,55	24'9"	4,35	14'3"	370	11,7	8632	29,0	4210	20	5	60	16	1075	2370	2200	7'3"	720	2'4"	1970	6'6"
F90ACXP.24	7,3	52801	9,40	30'10"	6,10	20'0"	370	11,7	8632	29,0	4210	20	5	60	16	1140	2513	2225	7'4"	720	2'4"	1970	6'6"
F90AXP.23/L061	8,1	58587	12,30	40'4"	6,40	20'11"	370	11,7	8632	32,0	4640	20	5	60	16	1245	2747	2200	7'3"	885	2'11"	1970	6'6"

Data and descriptions are approximate and not binding - Dati e dimensioni sono forniti a titolo indicativo e non impegnativo - Toutes les données et descriptions sont fournies à titre indicatif, sans engagement Unverbindliche Angaben, Konstruktionsänderungen vorbehalten - Datos y descripciones todos a título indicativo y no imperativo - Specificaties zijn niet bindend, wijzigingen derhalve voorbehouden



FASSI GRU S.p.A. - Via Roma, 110 - 24021 Albino (Bergamo) ITALY
 Tel: +39 035 776400 - Fax +39 035 755020
 http://www.fassigroup.com E-mail: fassi@fassigroup.com

